

For professional use only. Please refer to the conditions of use of our catalogue.

March 2002

4GDS25 133x190L code Z18-12

Voltage	Frequency	Input power	Current	Capacitor	Air flow	Rotational speed	Sound level	Direction of rotation	Max. Air temp.
V	Hz	Wa	A	µF	m ³ /h	rpm	dBA	↻	°C
230	50	76	0,35	2	680	1160	50	L	-20 / +70
230	60	90	0,42	2	695	1230	52	L	-20 / +70

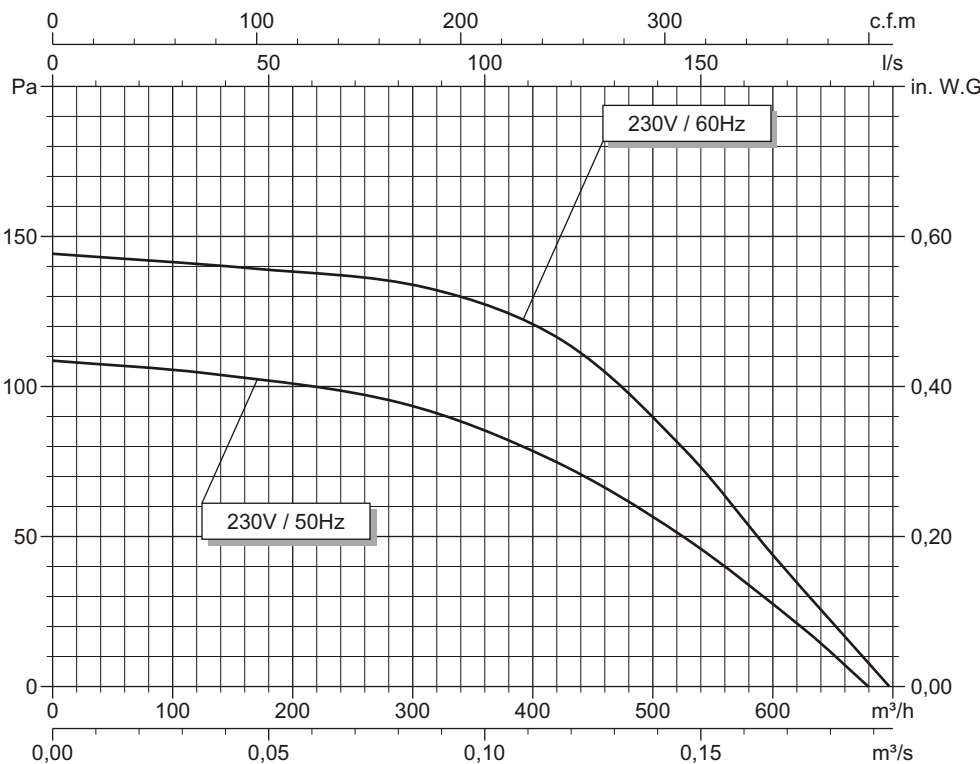
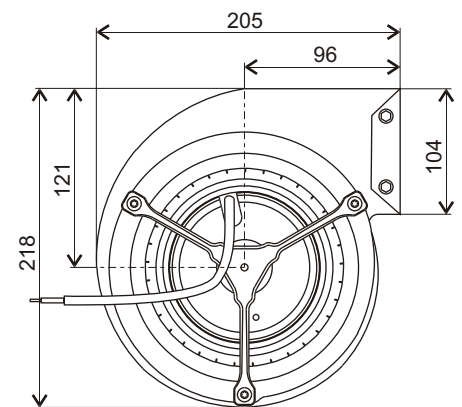
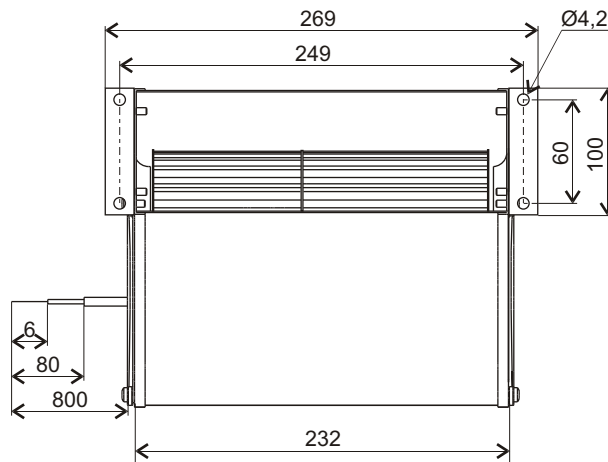

- Ball bearings.
- Cl.F windings protected by thermal cut-out.
- Protection IP 44.
- Balancing G2.5.
- Steel painted black scroll.
- Galvanised steel impeller

