

For professional use only. Please refer to the conditions of use of our catalogue.

March 2002

## 4GDS35 160x160L code Z18-24

Voltage	Frequency	Input power	Current	Capacitor	Air flow	Rotational speed	Sound level	Direction of rotation	Max. Air temp.
V	Hz	Wa	A	µF	m <sup>3</sup> /h	rpm	dBA	↻	°C
230	50	113	0,51	3	865	1025	53	L	-20 / +70
230	60	135	0,61	3	845	1010	53	L	-20 / +70

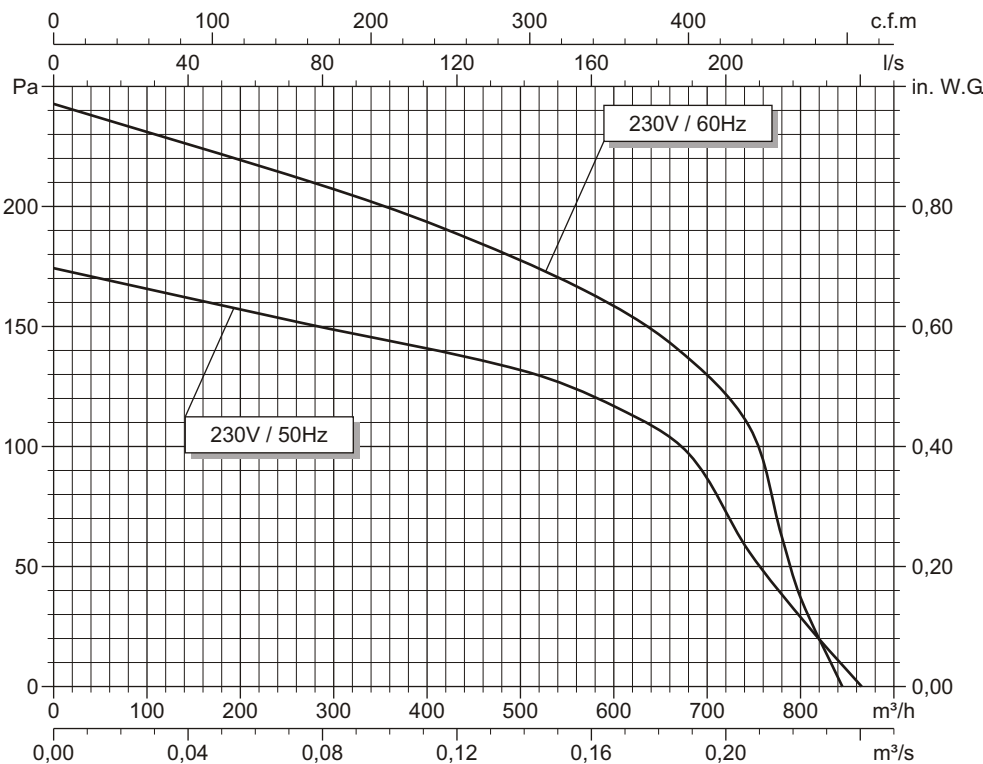
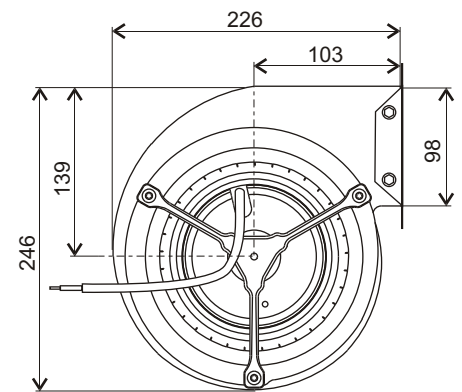
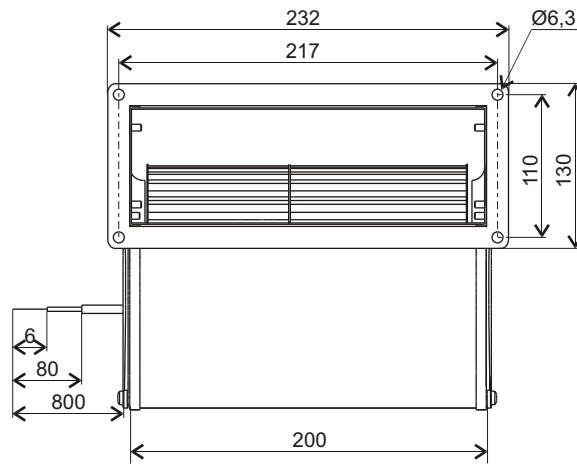

- Ball bearings.
- Cl.F windings protected by thermal cut-out.
- Protection IP 44.
- Balancing G2.5.
- Steel painted black scroll.
- Galvanised steel impeller

